

Strut and Yoke Assembly  
Part c3

What is the purpose of the 1/2" notch?

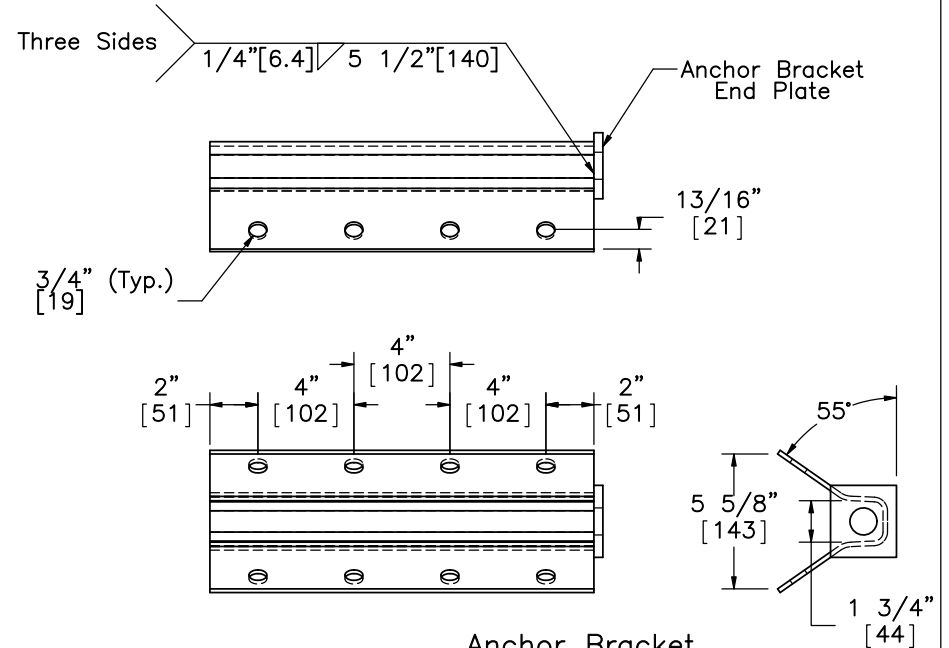

Anchor Bracket  
(FPA01)  
Part c6  
SCALE 1:8

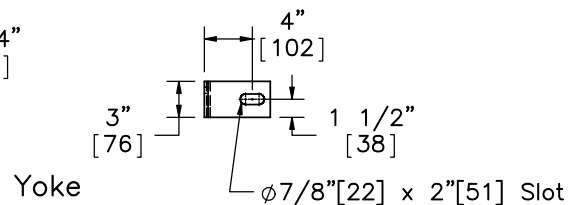
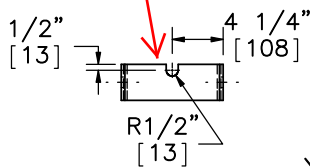
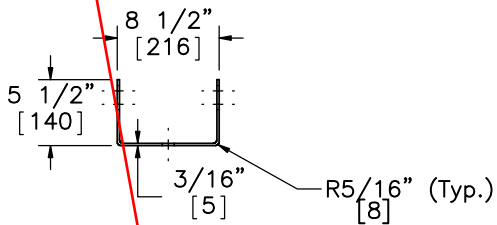
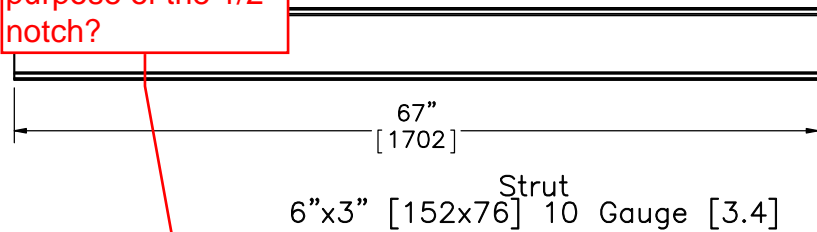
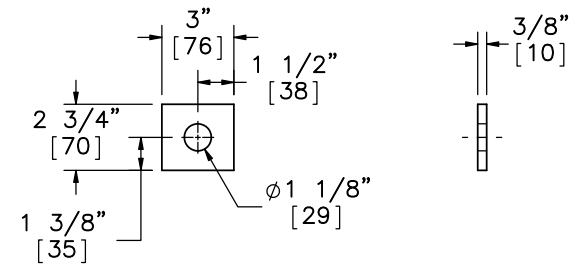
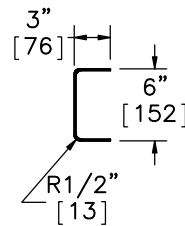

Anchor Bracket End Plate  
SCALE 1:8



Midwest Roadside  
Safety Facility

Wisconsin DOT Project  
MGS with Standard  
Downstream Anchorage  
System

Ground Strut &  
Anchor Bracket Details

DWG. NAME:  
DS-Anchorage-32in\_R3

SCALE: 1:16  
UNITS: in.[mm]

SHEET:  
9 of 11

DATE:  
5/25/2012

DRAWN BY:  
CWP

REV. BY:  
KAL/RKF