

Plan View
Flare Rate 7:1

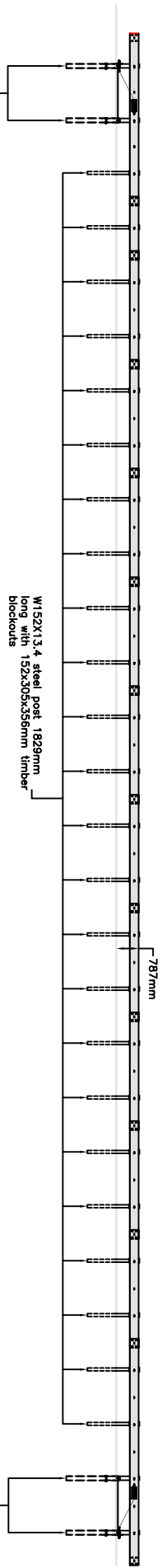

Front Elevation

BCI posts in 1829mm long foundation tubes ground line strut & BCI cable anchor.

BCI posts in 1829mm long foundation tubes ground line strut & BCI cable anchor.

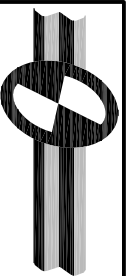

Midwest Roadside Safety Facility

Flare Rate Study (FRS)
Midwest Guardrail System
Layout for 7:1 Flare Impact
with 8200' Test Vehicle

Sheet:	1 of 6
Date:	08/15/2005
By:	GEP
Rev:	KAP
Drawing Name:	FRS-3 R2.dwg
Scale:	None

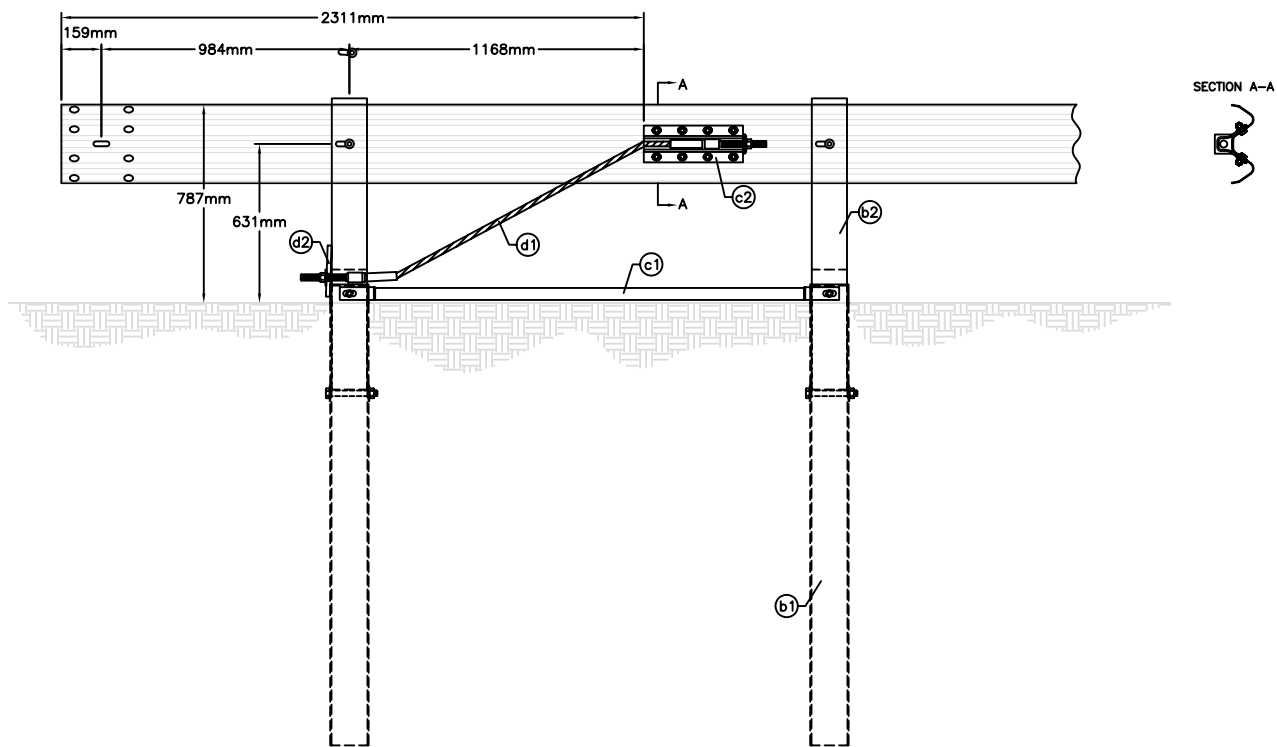
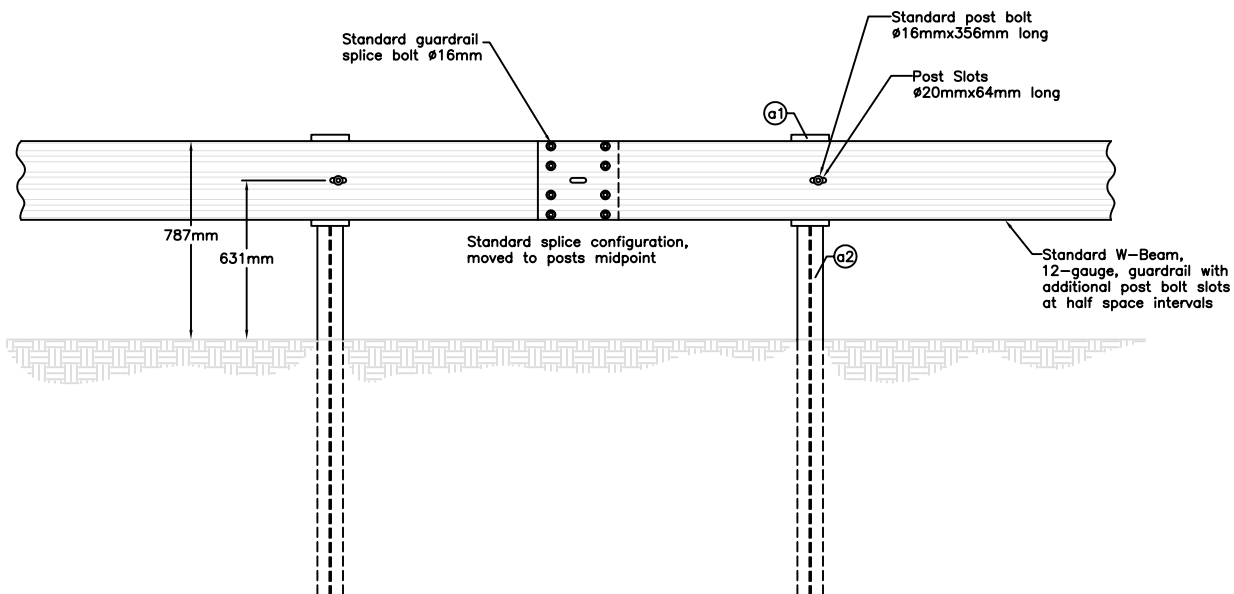

**Midwest Roadside
Safety Facility**

**Flare Rate Study (FRS)
Midwest Guardrail System**

Rail Detail

Sheet:
2 of 6
Date:
08/15/2005
By:
GEP
Rev:
KAP

Drawing Name:
FRS-3 R2.dwg

Scale:
1=30

ITEM	QTY	DESCRIPTION	MATERIAL

**W-BEAM POST
(Part a1)**

FRONT VIEW

SIDE VIEW

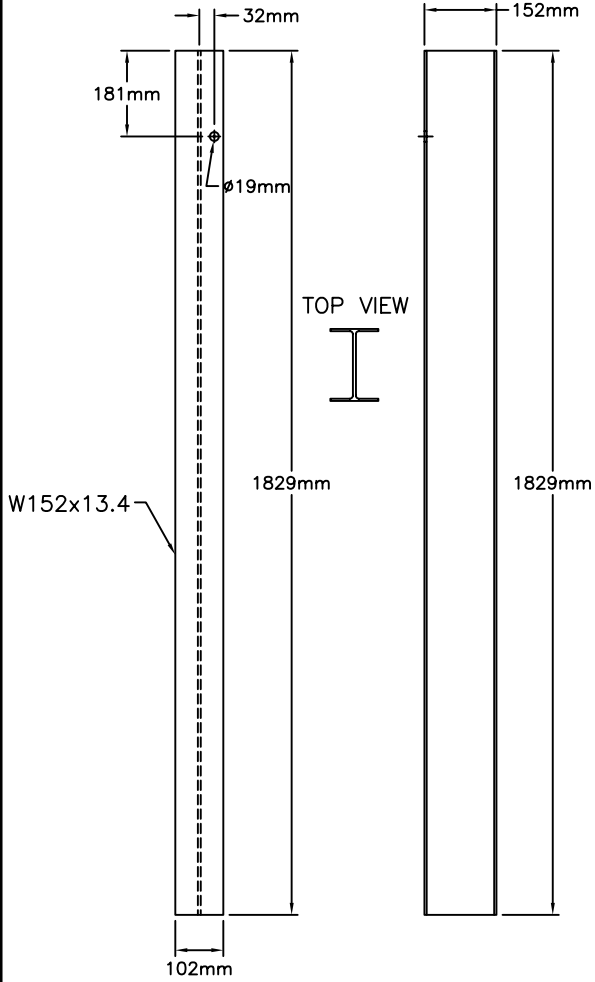

**W-BEAM SPACER
(Part a2)**

TOP VIEW

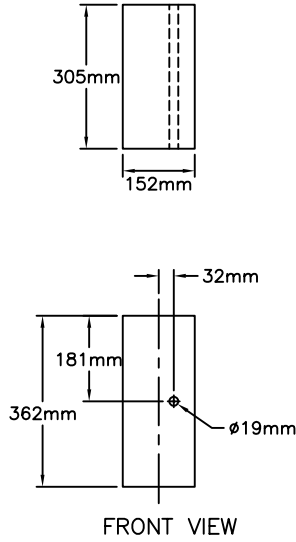

W-BEAM SUPPORT DETAILS

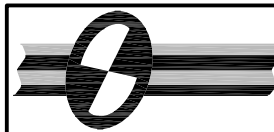
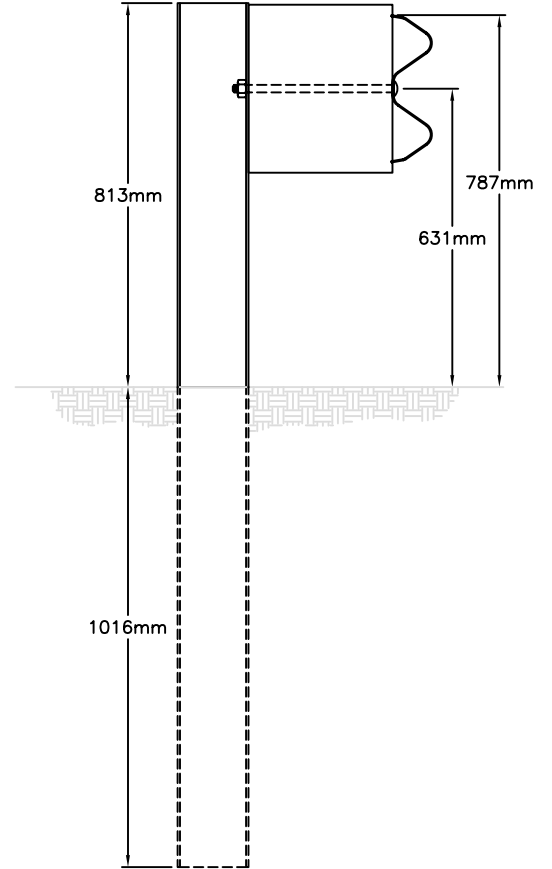

**Midwest Roadside
Safety Facility**

**Flare Rate Study (FRS)
Midwest Guardrail System**

Post Detail

Sheet:
3 of 6
Date:
08/15/2005
By:
GEP
Rev:
KAP

Drawing Name:
FRS-3 R2.dwg

Scale:
1=16

ITEM QTY	DESCRIPTION	MATERIAL

**FOUNDATION TUBE
(Part b1)**

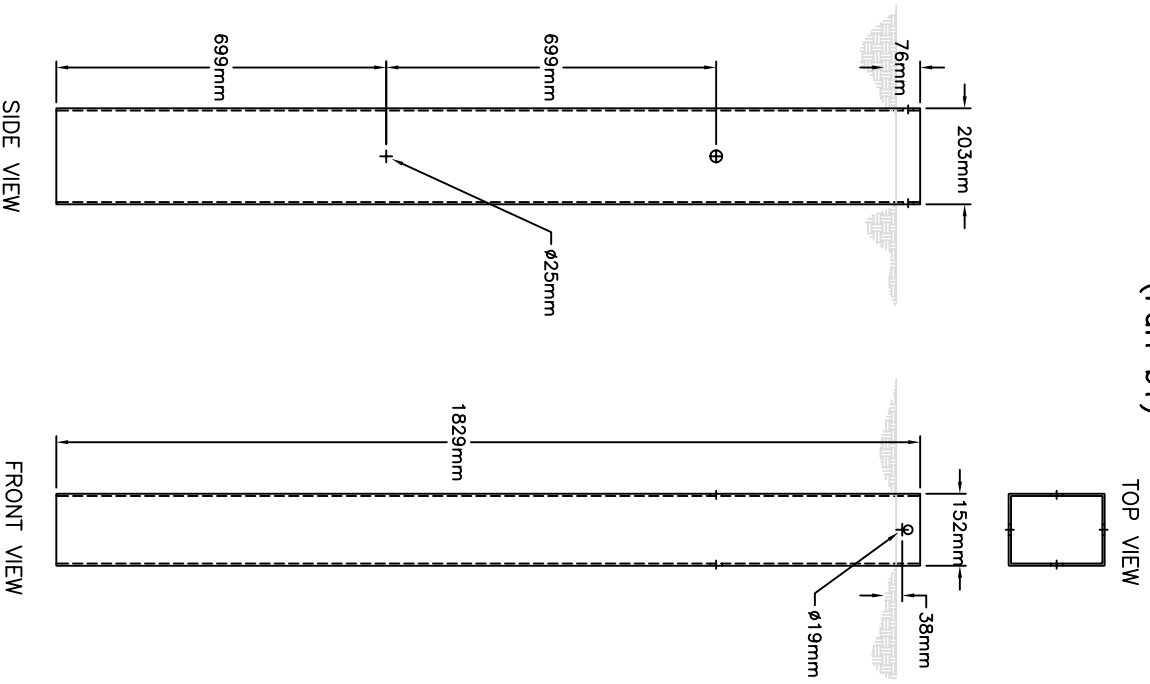

**BCT TIMBER POST
(Part b2)**

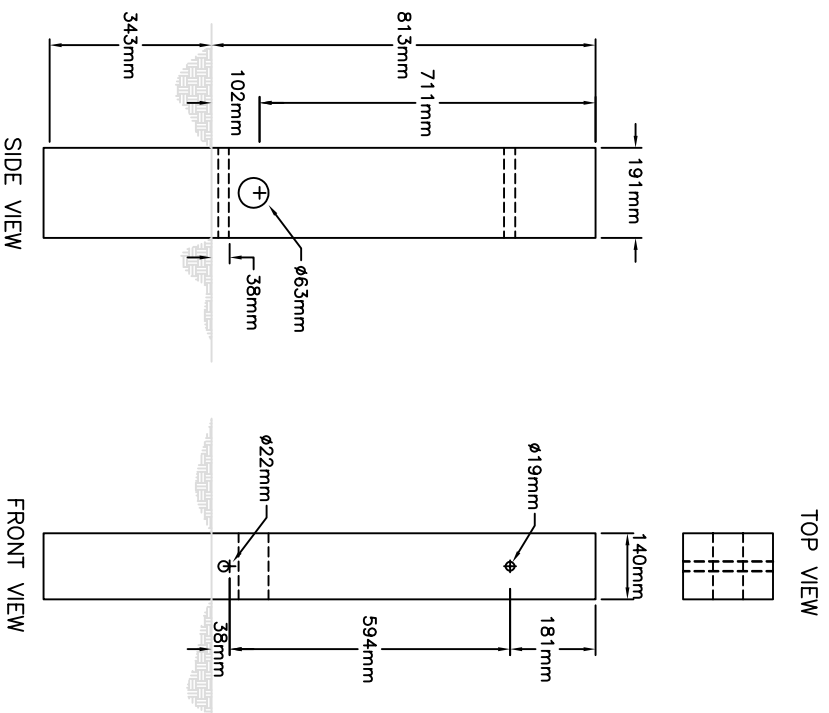

	Flare Rate Study (FRS) Midwest Guardrail System		Sheet: 4 of 6
	BCT Post & Tube Detail		Date: 08/15/2005
Drawing Name: FRS-3 R2.dwg	Scale: 1=16	By: GEP	Rev: KAP
Midwest Roadside Safety Facility			

ITEM QTY	DESCRIPTION	MATERIAL

Yoke Details

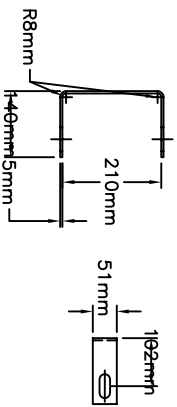

Strut Details

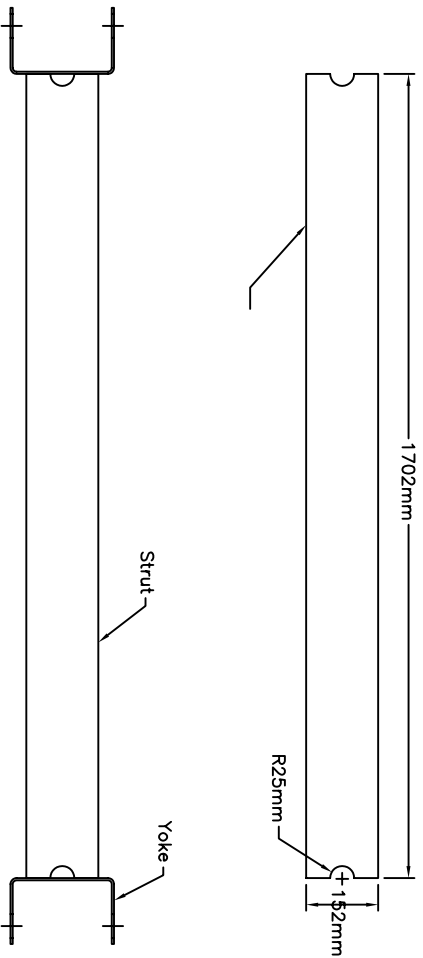

Cable Strut
(Part c1)

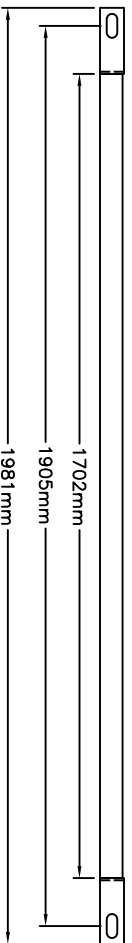

Anchor Bracket
(Part c2)

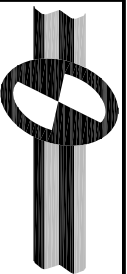
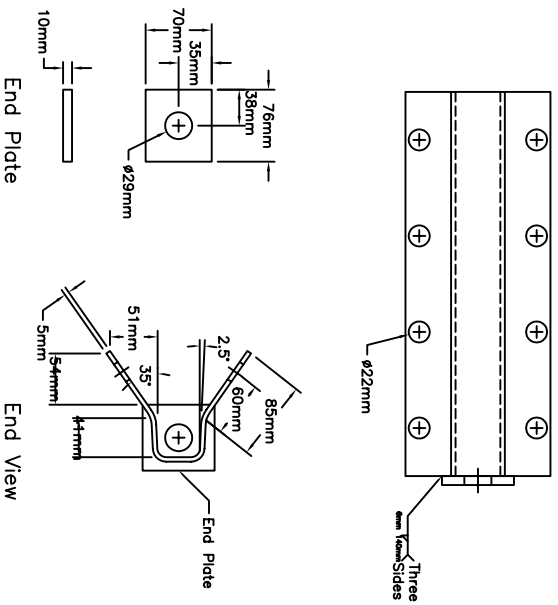

Midwest Roadside
Safety Facility

Flare Rate Study (FRS)
Midwest Guardrail System

Cable Strut &
Anchor Bracket

Drawing Name:
FRS-3 R2.dwg

Scale:
None

Sheet:
5 of 6

Date:
08/15/2005

By:
GEP

Rev:
KAP

ITEM	QTY	DESCRIPTION	MATERIAL

**Anchor Cable
(Part d1)**

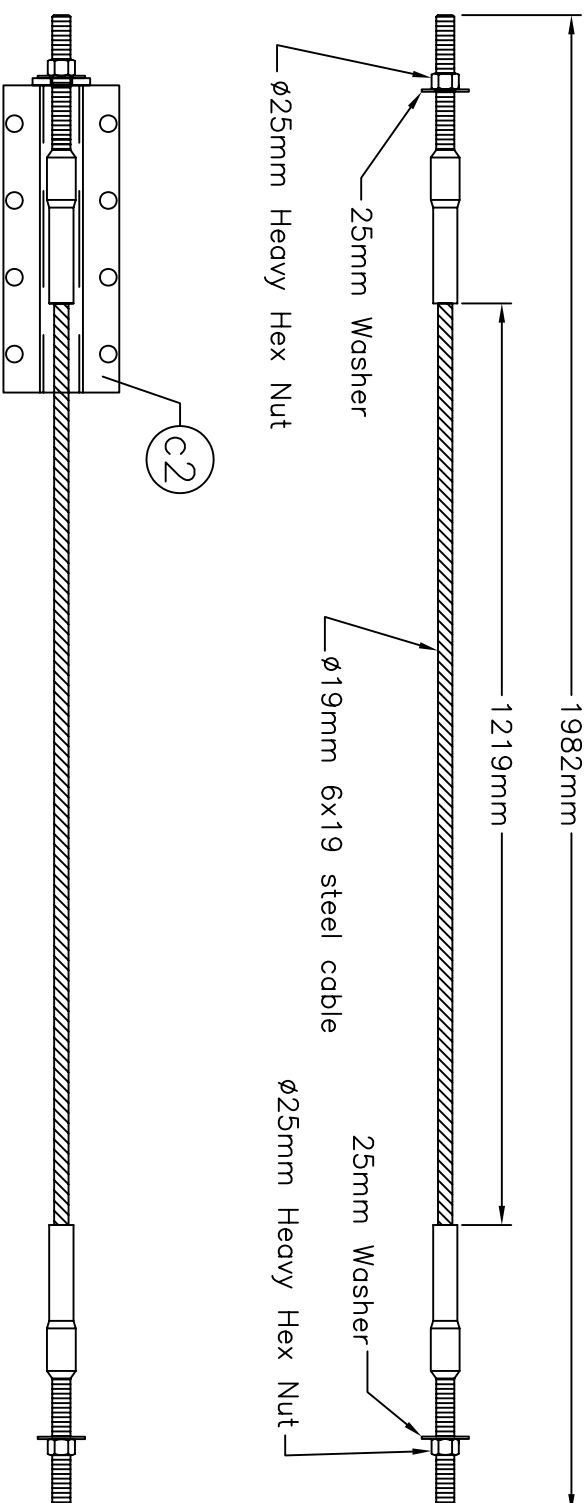

**Bearing Plate
(Part d2)**

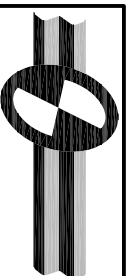
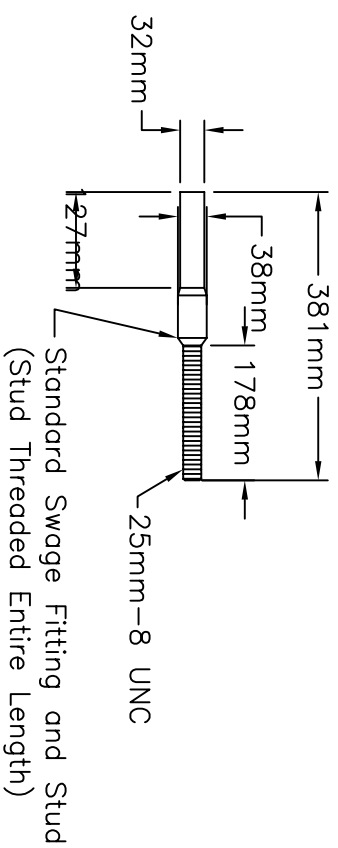
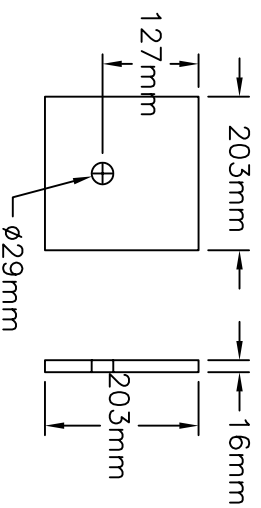

**Midwest Roadside
Safety Facility**

**Flare Rate Study (FRS)
Midwest Guardrail System
BCT Anchor Cable Detail**

Drawing Name:
FRS-3 R2.dwg

Scale:
1=10

Rev:
KAP

Sheet:
6 of 6

Date:
08/15/2005

By:
GEP